



SANYO Semiconductors

DATA SHEET

An ON Semiconductor Company

LV47017P — Monolithic Linear IC For Car Audio Systems 4-Channel BTL Power Amplifier

Overview

The LV47017P is the IC for 4-channel BTL power amplifier that is developed for car audio system.

Pch DMOS in the upper side of the output stage and Nch DMOS in the lower side of the output stage are complimentary. High power and high quality sound are realized by that.

This IC incorporate various functions (standby switch, muting function, and various protection circuit) necessary for car audio system. Also, it has a self-diagnosis function.

Functions

- High output : P_O max = 48W (typical) ($V_{CC} = 15.2V$, $f = 1kHz$, JEITA max, $R_L = 4\Omega$)
: P_O max = 28W (typical) ($V_{CC} = 14.4V$, $f = 1kHz$, THD = 10%, $R_L = 4\Omega$)
: P_O max = 21W (typical) ($V_{CC} = 14.4V$, $f = 1kHz$, THD = 1%, $R_L = 4\Omega$)
- Built-in muting function (pin 22)
- Built-in Standby switch (pin 4)
- Built-in Self-diagnosis function (pin 25) :
Signal output in case of output offset detection, shorting to V_{CC} , shorting to ground, and load shorting.
- Electric mirror noise decrease
- Built-in various protection circuit (shorting to ground, shorting to V_{CC} , load shorting, over voltage and thermal shut down)
- No external anti-oscillation part necessary.

Note 1 : Please do not mistake connection.

A wrong connection may produce destruction, deterioration and damage for the IC or equipment.

Note 2 : The protective circuit function is provided to temporarily avoid abnormal state such as incorrect output connection.

But, there is no guarantee that the IC is not destroyed by the accident.

The protective function do not operate of the operation guarantee range. If the outputs are connected incorrectly, IC destruction may occur when used outside of the operation guarantee range.

Note 3 : External parts, such as the anti-oscillation part, may become necessary depending on the set condition. Check their necessity for each set.

■ Any and all SANYO Semiconductor Co.,Ltd. products described or contained herein are, with regard to "standard application", intended for the use as general electronics equipment. The products mentioned herein shall not be intended for use for any "special application" (medical equipment whose purpose is to sustain life, aerospace instrument, nuclear control device, burning appliances, transportation machine, traffic signal system, safety equipment etc.) that shall require extremely high level of reliability and can directly threaten human lives in case of failure or malfunction of the product or may cause harm to human bodies, nor shall they grant any guarantee thereof. If you should intend to use our products for new introduction or other application different from current conditions on the usage of automotive device, communication device, office equipment, industrial equipment etc. , please consult with us about usage condition (temperature, operation time etc.) prior to the intended use. If there is no consultation or inquiry before the intended use, our customer shall be solely responsible for the use.

■ Specifications of any and all SANYO Semiconductor Co.,Ltd. products described or contained herein stipulate the performance, characteristics, and functions of the described products in the independent state, and are not guarantees of the performance, characteristics, and functions of the described products as mounted in the customer's products or equipment. To verify symptoms and states that cannot be evaluated in an independent device, the customer should always evaluate and test devices mounted in the customer's products or equipment.

SANYO Semiconductor Co., Ltd.

<http://semicon.sanyo.com/en/network>

LV47017P

Specifications

Maximum Ratings at $T_a = 25^\circ\text{C}$

Parameter	Symbol	Conditions	Ratings	Unit
Maximum supply voltage	$V_{CC\ max1}$	Without signal, $t = 1\ \text{minute}$	26	V
	$V_{CC\ max2}$	With signal	18	V
Maximum output current	$I_O\ \text{peak}$	Per channel	4.5/ch	A
Allowable power dissipation	$P_d\ \text{max}$	With an infinity large heat sink	50	W
Operating temperature	T_{opr}		-40 to +85	$^\circ\text{C}$
Storage temperature	T_{stg}		-40 to +150	$^\circ\text{C}$
Thermal resistance between the junction and case	θ_{j-c}		1	$^\circ\text{C/W}$

Recommended Operating Ranges at $T_a = 25^\circ\text{C}$

Parameter	Symbol	Conditions	Ratings	Unit
Recommended supply voltage	V_{CC}		14.4	V
Recommended load resistance	$R_L\ \text{op}$		4	Ω
Operating supply voltage range	$V_{CC\ \text{op}}$	A range not exceeding $P_{d\ \text{max}}$	9 to 16	V

Electrical Characteristics at $T_a = 25^\circ\text{C}$, $V_{CC} = 14.4\text{V}$, $R_L = 4\Omega$, $f = 1\text{kHz}$, $R_g = 600\Omega$

Parameter	Symbol	Conditions	Ratings			Unit
			min	typ	max	
Quiescent current	I_{CCO}	$R_L = \infty$, $R_g = 0\Omega$		200	400	mA
Standby current	I_{st}	$V_{st} = 0\text{V}$			10	μA
Voltage gain	VG	$V_O = 0\text{dBm}$	25	26	27	dB
Voltage gain difference	ΔVG		-1		+1	dB
Output power	P_O	THD = 10%	23	28		W
	$P_O\ \text{max1}$	Max Power		43		W
	$P_O\ \text{max2}$	$V_{CC} = 15.2$, Max Power		48		W
Output offset voltage	$V_n\ \text{offset}$	$R_g = 0\Omega$	-100		+100	mV
Total harmonic distortion	THD	$P_O = 4\text{W}$		0.03	0.2	%
Channel separation	CHsep	$V_O = 0\text{dBm}$, $R_g = 10\text{k}\Omega$	55	65		dB
Ripple rejection ratio	SVRR	$R_g = 0\Omega$, $f_r = 100\text{Hz}$, $V_{CCR} = 0\text{dBm}$	45	65		dB
Output noise voltage	V_{NO}	$R_g = 0\Omega$, B.P.F. = 20Hz to 20kHz		80	200	μVrms
Input resistance	R_i		40	50	65	$\text{k}\Omega$
Mute attenuation	Matt	$V_O = 20\text{dBm}$, mute : on	75	90		dB
Standby pin control voltage	Vstby H	Amp : on	2.5		V_{CC}	V
	Vstby L	Amp : off	0.0		0.5	V
Mute pin control voltage	Vmute H	Mute : off	Open			-
	Vmute L	Mute : on	0.0		1.0	V

* 0dBm = 0.775Vrms

LV47017P

Package Dimensions

unit : mm (typ)
3236A

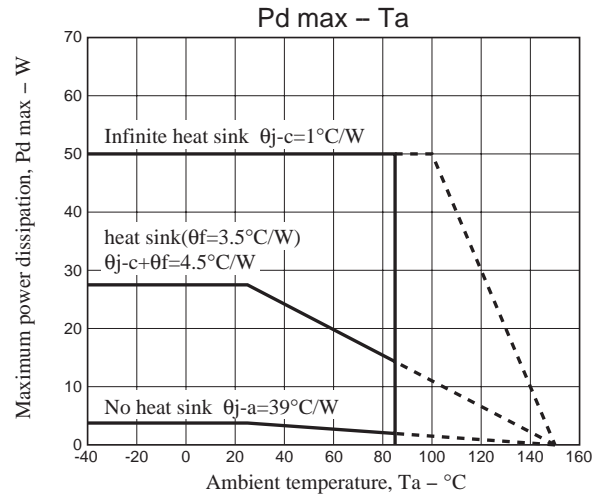
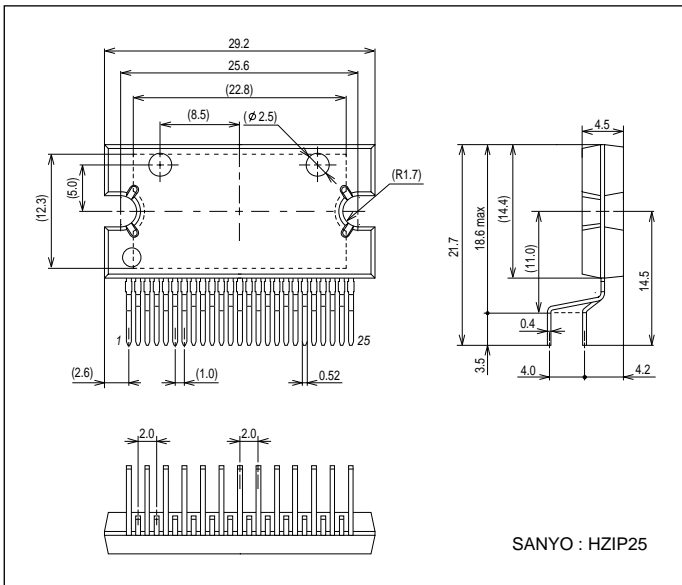

Block Diagram

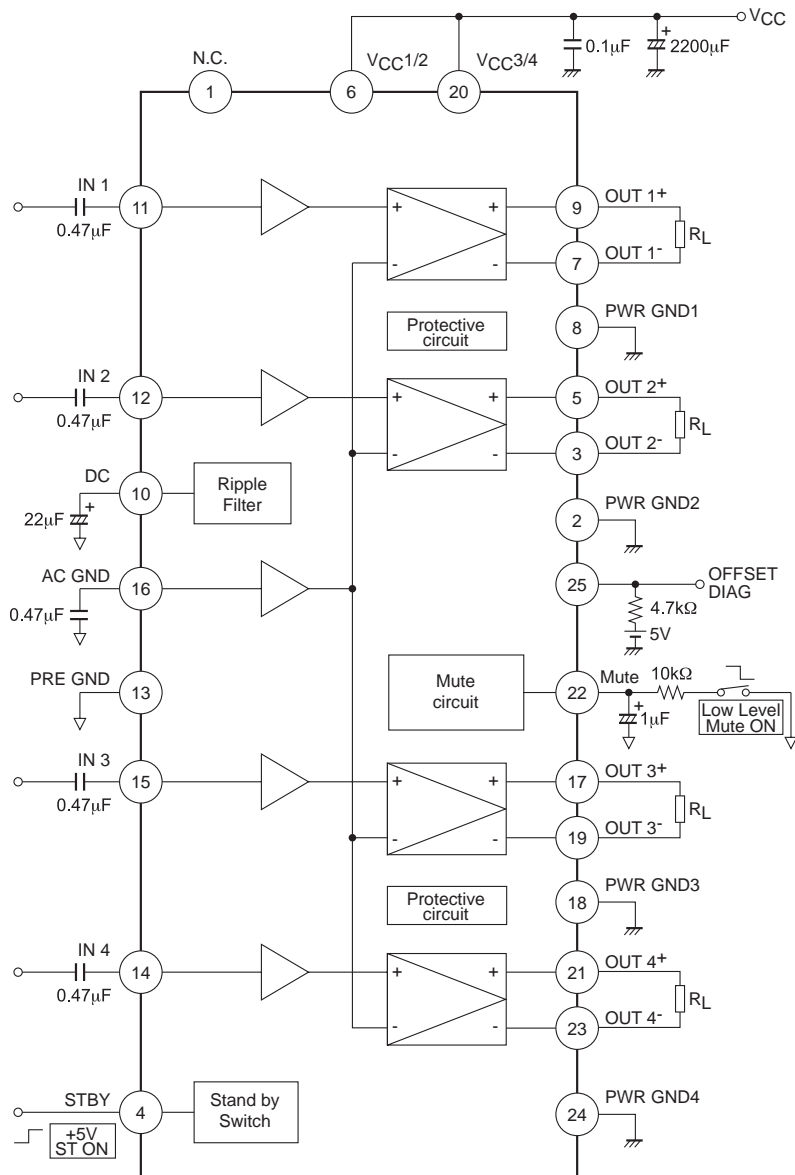

LV47017P

External Components

Part Name	Recommended Value	Purpose	Remarks
C1 to C5	0.47 μ F	Cuts DC voltage	The larger the constant value, the lower the cut-off frequency The values of C1 to C5 must be the same
C6	22 μ F	Reduces ripples Reduces pop noise	The larger the constant value, the longer the amplifier ON/OFF time
C7	2200 μ F	Ripple filter	Eliminating power supply ripples
C8	0.1 μ F	Improves oscillation stability	Reducing high-frequency noise
C9	1 μ F	Reduces pop noise	The larger the constant value, the longer the mute ON/OFF time
R1	10k Ω	Reduces pop noise	The larger the constant value, the longer the mute ON/OFF time
R2	4.7k Ω	Pull-up resistor	

* The components and constant values within the test circuit are used for confirmation of characteristics and are not guarantees that incorrect or trouble will not occur in application equipment.

Description of Operation

1. Standby switch function (pin 4)

Threshold voltage of the pin 4 is set by about 2V_{BE}.

The amplifier is turned on by the applied voltage of 2.5V or more. Also, the amplifier is turned off by the applied voltage of 0.5V or less.

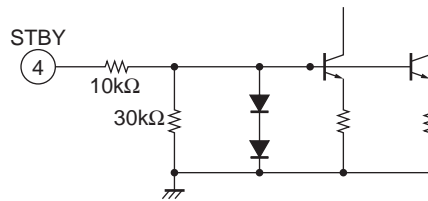

Fig1 Standby equivalent circuit

2. Muting function (pin 22)

The muted state is obtained by setting pin 22 to the ground potential, enabling audio muting.

The muting function is turned on by the applied voltage of 1V or less to the resistance of 10k Ω . And the muting function is turn off when this pin opens.

Also, the time constant of the muting function is determined by external capacitor and resistor constants.

It is concerned with a pop noise in amplifier ON/OFF and mute ON/OFF. After enough examination, please set it.

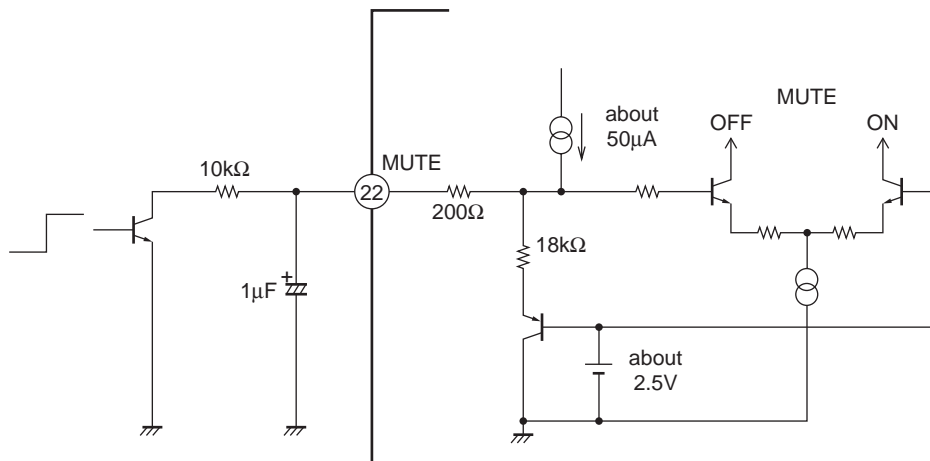

Fig2 Mute equivalent circuit

3. ACGND pin (pin 16)

The capacitor of the pin 16 must use the same capacitance value as the input capacitor.

Also, connect to the same PREGND as the input capacitor.

4. Self-diagnostics function (pin 25)

By detecting the unusual state of the IC, the signal is output to the pin 25.

Also, by controlling the standby switch after the signal of the pin 25 is detected by the microcomputer, the burnout of the speaker can be prevented.

- (1) Shorting to V_{CC} /Shorting to ground : The pin 25 becomes the low level.
- (2) Load shorting : The pin 25 is alternated between the low level and the high level according to the output signal.
- (3) Output offset detection : when the output offset voltage exceeds the detection threshold voltage, the pin 25 becomes the low level.

* Note: The output offset abnormality is thought of as the leakage current of the input capacitor.

In addition, the pin 25 has become the NPN open collector output (active low).

The pin 25 must be left open when this function is not used.

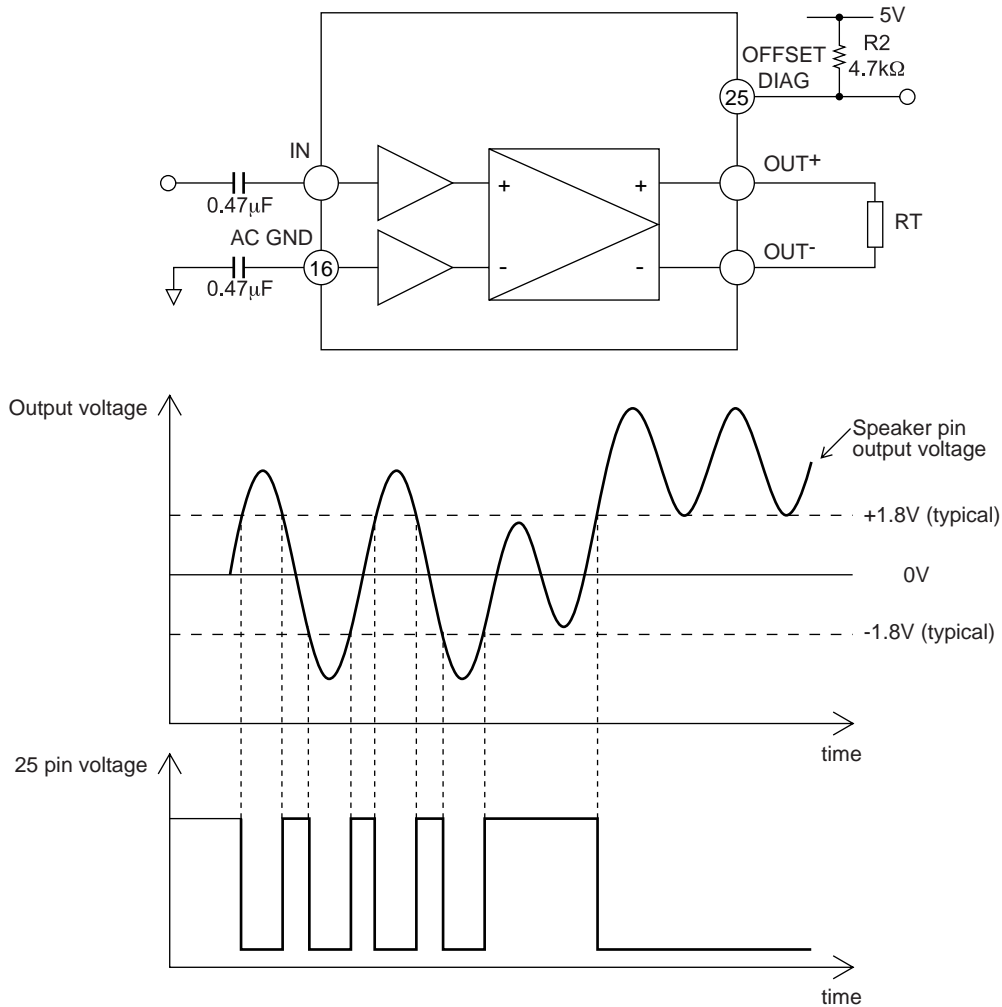

Fig3 Self-diagnosis Function Diagram

5. Sound quality (low frequencies)

By varying the value of input capacitor, low-frequency characteristic can be improved.

However, it is concerned the shock noise. Please confirm in each set when the capacitance value varies.

6. Pop noise

For pop noise prevention, it is recommended to use the muting function at the same time.

- Please turn on the muting function simultaneously with power supply on when the amplifier is turned on. Next, turn off the muting function after the output DC potential stabilization.
- When the amplifier is turn off, turn off the power supply after turning on the muting function.

7. Oscillation stability

Pay due attention on the following points because parasitic oscillation may occur due to effects of the capacity load, board layout, etc.

(1) Capacity load

When the capacitor is to be inserted between each output pin and GND so as to prevent electric mirror noise, select the capacitance of maximum 1500pF. (Conditions : Our recommended board, $R_L = 4\Omega$)

(2) Board layout

- Provide the V_{CC} capacitor of $0.1\mu\text{F}$ in the position nearest to IC.
- PREGND must be independently wired and connected to the GND point that is as stable as possible, such as the minus pin of the $2200\mu\text{F}$ V_{CC} capacitor.

In case of occurrence of parasitic oscillation, any one of following parts may be added as a countermeasure.

Note that the optimum capacitance must be checked for each set in the mounted state.

- Series connection of CR ($0.1\mu\text{F}$ and 2.2Ω) between BTL outputs
- Series connection of CR($0.1\mu\text{F}$ and 2.2Ω) between each output pin and GND.

LV47017P

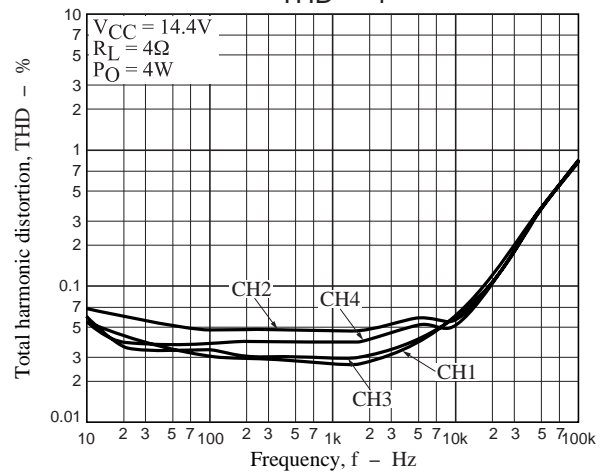
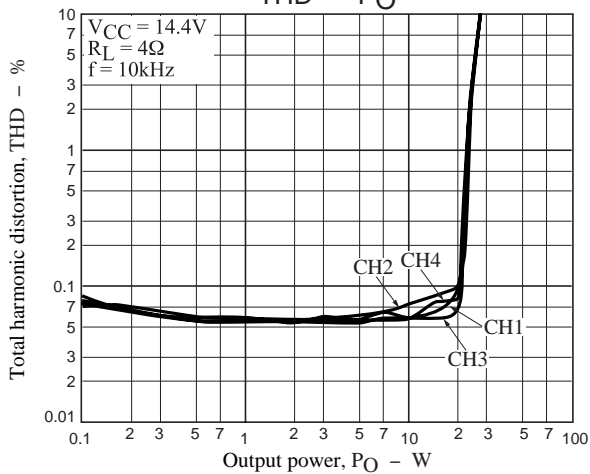
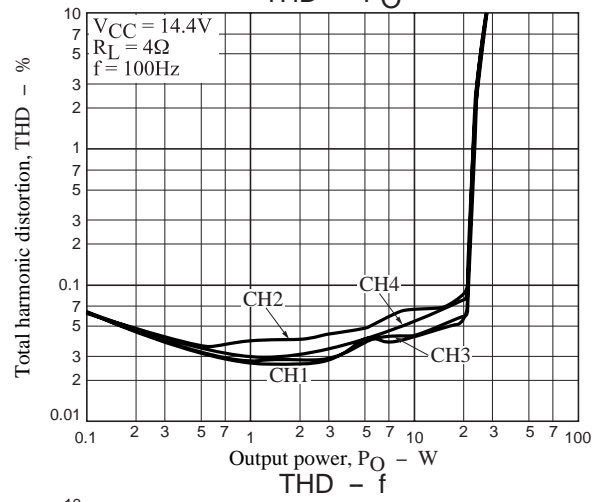
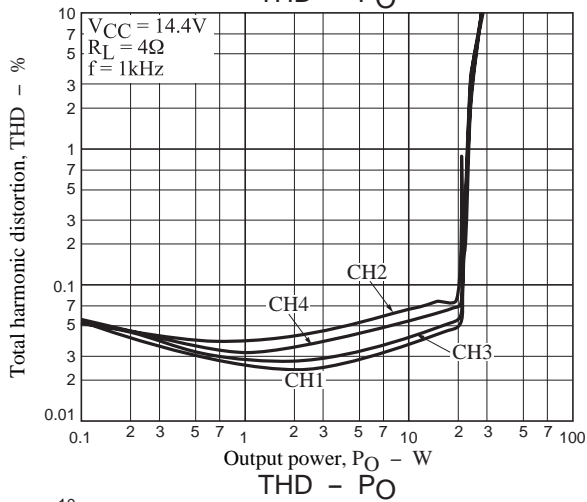
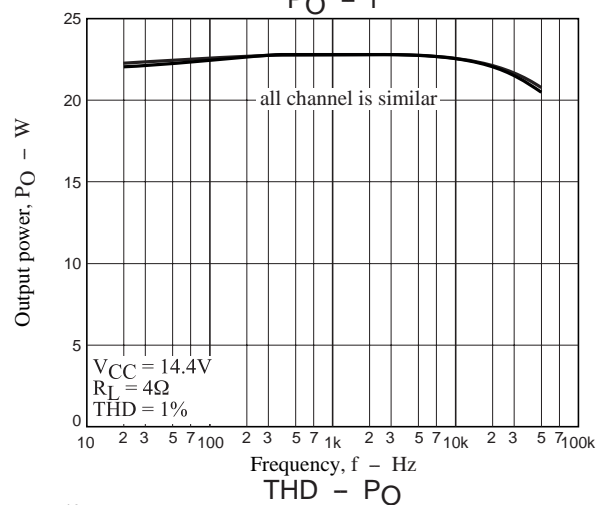
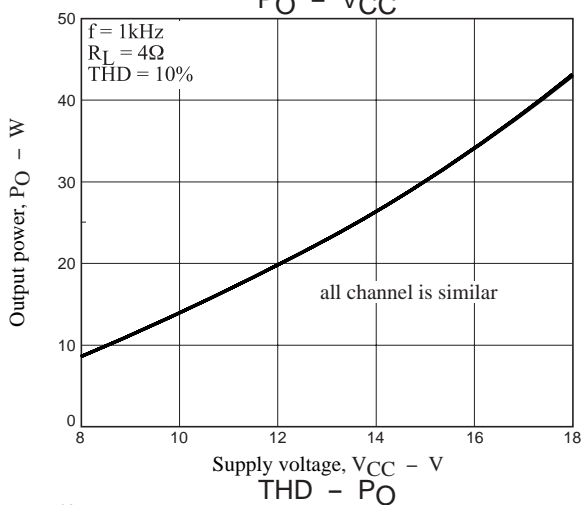
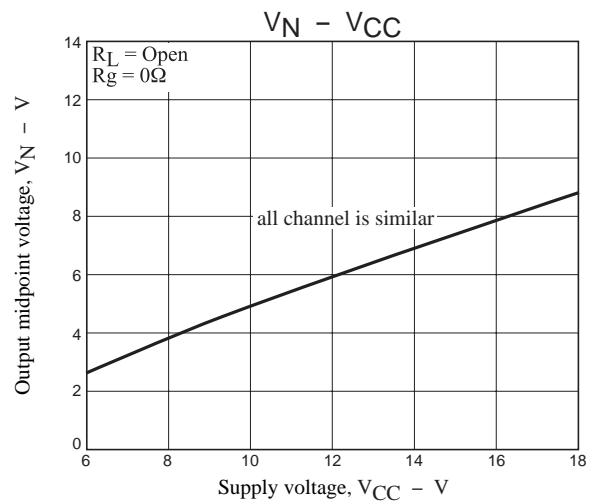
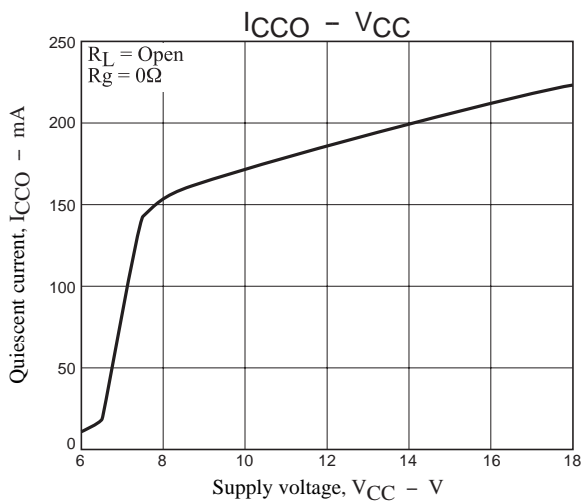

LV47017P

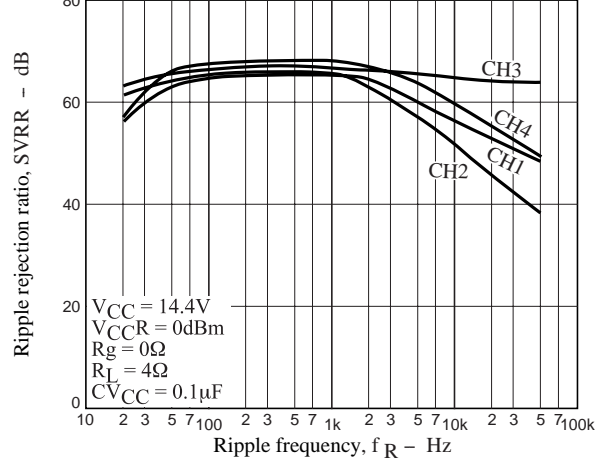
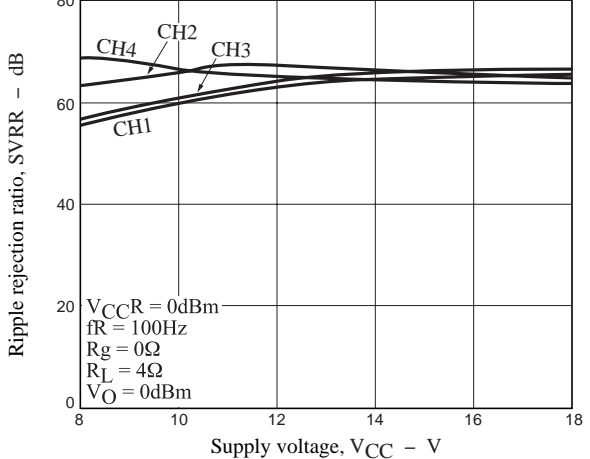
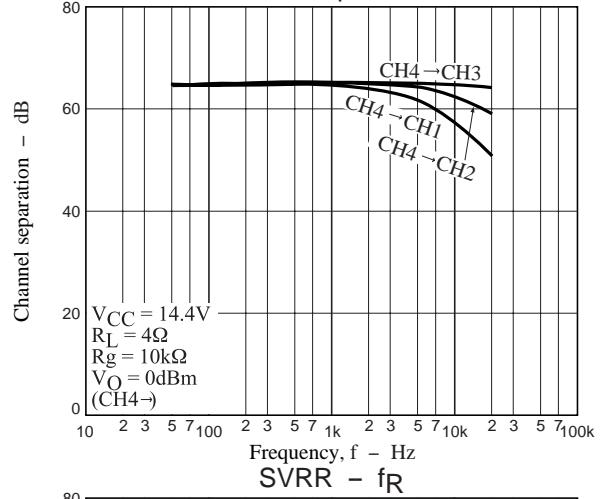
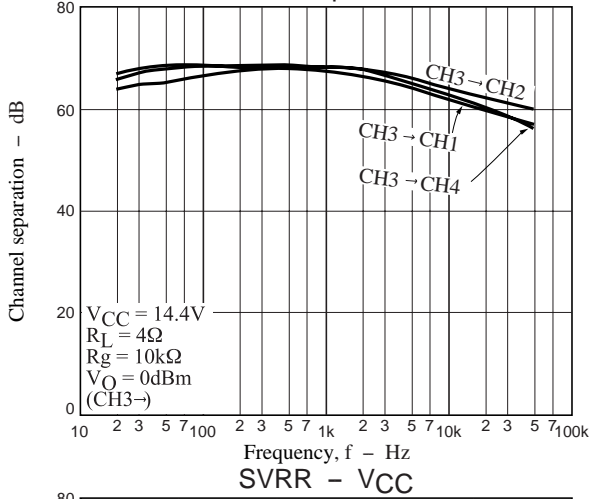
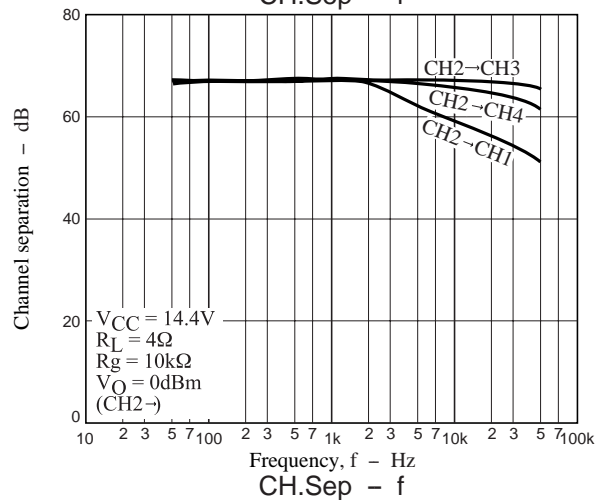
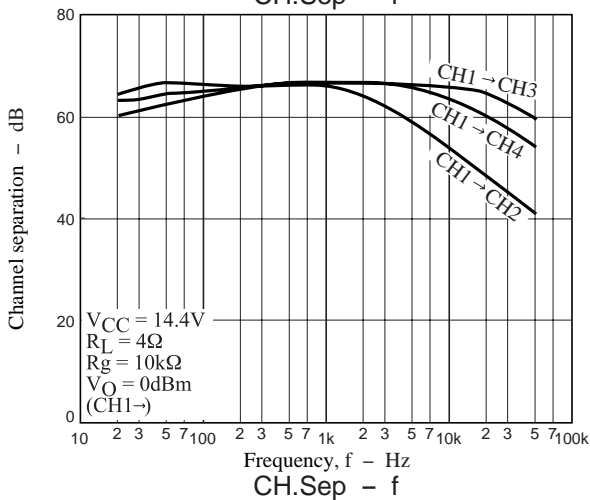
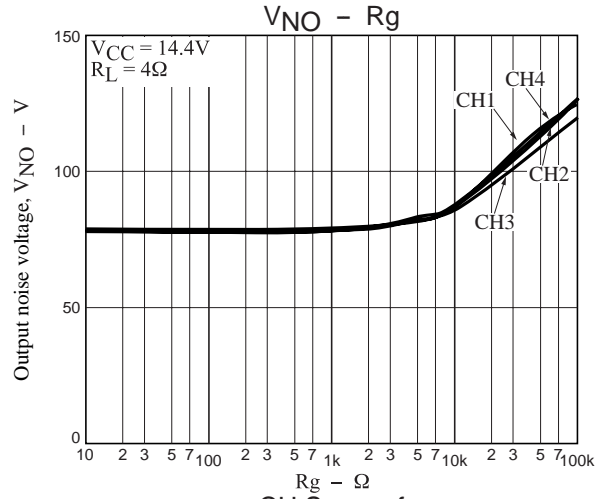
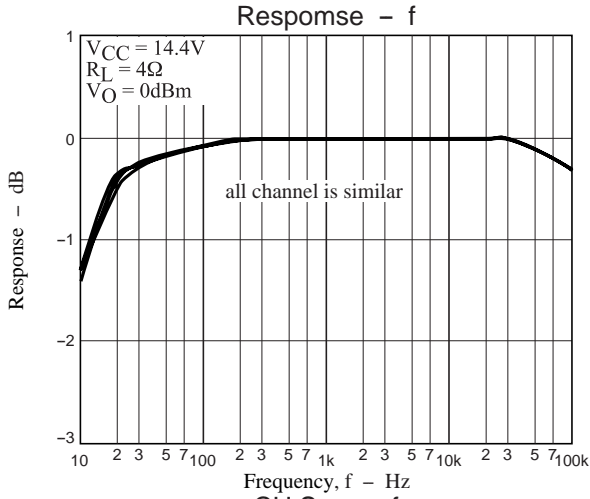

LV47017P

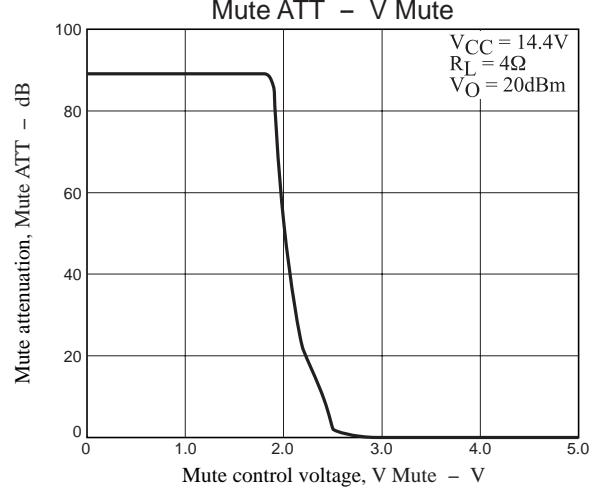
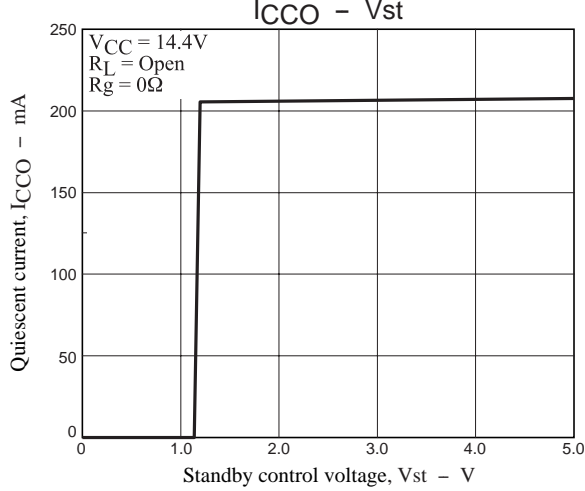
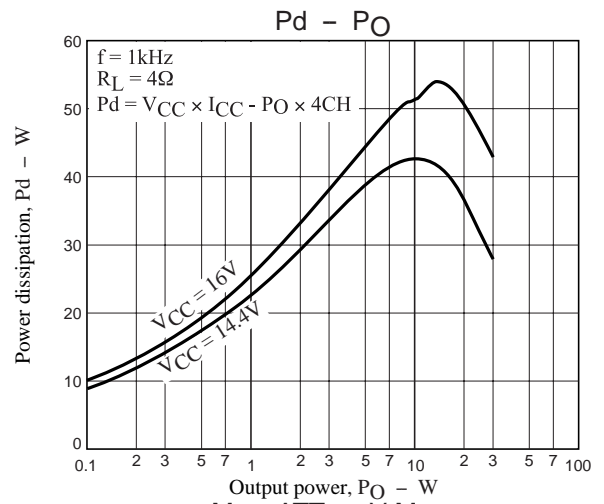
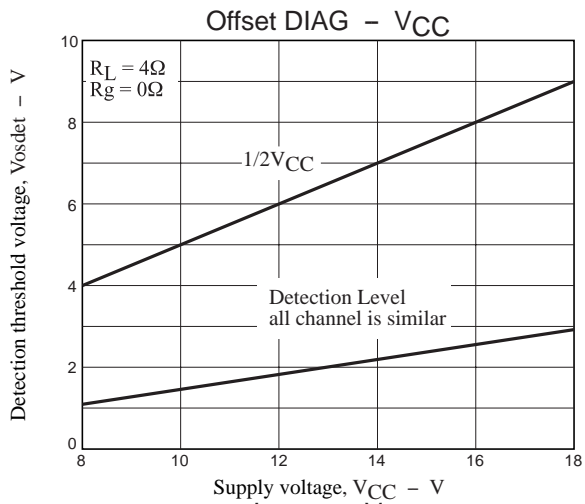

HZIP25 Heat sink attachment

Heat sinks are used to lower the semiconductor device junction temperature by leading the heat generated by the device to the outer environment and dissipating that heat.

- a. Unless otherwise specified, for power ICs with tabs and power ICs with attached heat sinks, solder must not be applied to the heat sink or tabs.

b. Heat sink attachment

- Use flat-head screws to attach heat sinks.
- Use also washer to protect the package.
- Use tightening torques in the ranges 39-59Ncm(4-6kgcm) .
- If tapping screws are used, do not use screws with a diameter larger than the holes in the semiconductor device itself.
- Do not make gap, dust, or other contaminants to get between the semiconductor device and the tab or heat sink.
- Take care a position of via hole .
- Do not allow dirt, dust, or other contaminants to get between the semiconductor device and the tab or heat sink.
- Verify that there are no press burrs or screw-hole burrs on the heat sink.
- Warping in heat sinks and printed circuit boards must be no more than 0.05 mm between screw holes, for either concave or convex warping.
- Twisting must be limited to under 0.05 mm.
- Heat sink and semiconductor device are mounted in parallel.
Take care of electric or compressed air drivers
- The speed of these torque wrenches should never exceed 700 rpm, and should typically be about 400 rpm.

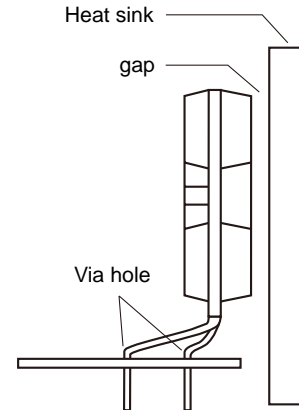
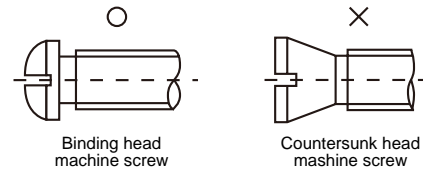

c. Silicone grease

- Spread the silicone grease evenly when mounting heat sinks.
- Sanyo recommends YG-6260 (Momentive Performance Materials Japan LLC)

d. Mount

- First mount the heat sink on the semiconductor device, and then mount that assembly on the printed circuit board.
- When attaching a heat sink after mounting a semiconductor device into the printed circuit board, when tightening up a heat sink with the screw, the mechanical stress which is impossible to the semiconductor device and the pin doesn't hang.

e. When mounting the semiconductor device to the heat sink using jigs, etc.,

- Take care not to allow the device to ride onto the jig or positioning dowel.
- Design the jig so that no unreasonable mechanical stress is not applied to the semiconductor device.

f. Heat sink screw holes

- Be sure that chamfering and shear drop of heat sinks must not be larger than the diameter of screw head used.
- When using nuts, do not make the heat sink hole diameters larger than the diameter of the head of the screws used. A hole diameter about 15% larger than the diameter of the screw is desirable.
- When tap screws are used, be sure that the diameter of the holes in the heat sink are not too small. A diameter about 15% smaller than the diameter of the screw is desirable.

- g. There is a method to mount the semiconductor device to the heat sink by using a spring band. But this method is not recommended because of possible displacement due to fluctuation of the spring force with time or vibration.

- SANYO Semiconductor Co.,Ltd. assumes no responsibility for equipment failures that result from using products at values that exceed, even momentarily, rated values (such as maximum ratings, operating condition ranges, or other parameters) listed in products specifications of any and all SANYO Semiconductor Co.,Ltd. products described or contained herein.
- SANYO Semiconductor Co.,Ltd. strives to supply high-quality high-reliability products, however, any and all semiconductor products fail or malfunction with some probability. It is possible that these probabilistic failures or malfunction could give rise to accidents or events that could endanger human lives, trouble that could give rise to smoke or fire, or accidents that could cause damage to other property. When designing equipment, adopt safety measures so that these kinds of accidents or events cannot occur. Such measures include but are not limited to protective circuits and error prevention circuits for safe design, redundant design, and structural design.
- In the event that any or all SANYO Semiconductor Co.,Ltd. products described or contained herein are controlled under any of applicable local export control laws and regulations, such products may require the export license from the authorities concerned in accordance with the above law.
- No part of this publication may be reproduced or transmitted in any form or by any means, electronic or mechanical, including photocopying and recording, or any information storage or retrieval system, or otherwise, without the prior written consent of SANYO Semiconductor Co.,Ltd.
- Any and all information described or contained herein are subject to change without notice due to product/technology improvement, etc. When designing equipment, refer to the "Delivery Specification" for the SANYO Semiconductor Co.,Ltd. product that you intend to use.
- Upon using the technical information or products described herein, neither warranty nor license shall be granted with regard to intellectual property rights or any other rights of SANYO Semiconductor Co.,Ltd. or any third party. SANYO Semiconductor Co.,Ltd. shall not be liable for any claim or suits with regard to a third party's intellectual property rights which has resulted from the use of the technical information and products mentioned above.

This catalog provides information as of October, 2011. Specifications and information herein are subject to change without notice.

Mouser Electronics

Authorized Distributor

Click to View Pricing, Inventory, Delivery & Lifecycle Information:

[ON Semiconductor:](#)

[LV47017P-E](#)